

RoHS COMPLIANT

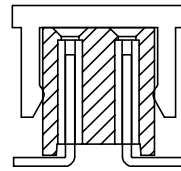

W/O Post

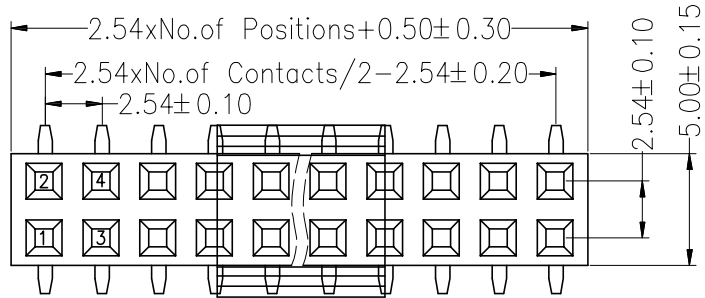
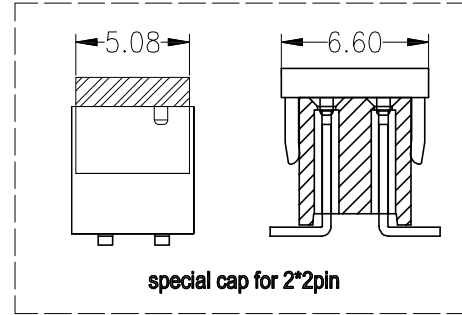

special cap for 2*2pin

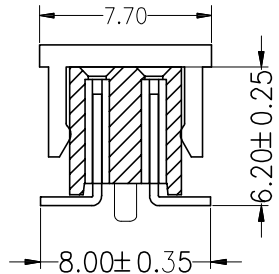
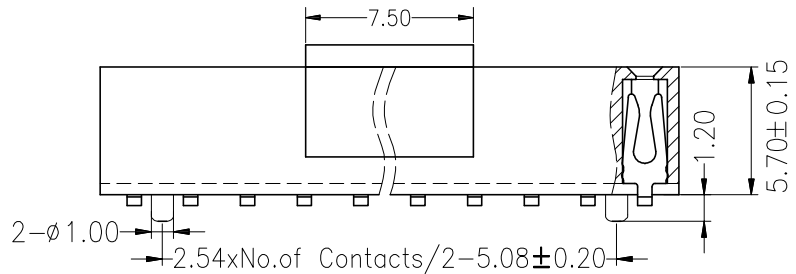

With Post

SPECIFICATIONS
 Rated Current:3.0AMP
 Contact Resistance:20mΩ Max
 Withstand Voltage:1000V AC/DC
 Insulation Resistance:1000MΩ Min
 Operation Temperature:-40°C to +105°C

Contact Material:Brass
 Contact Plating:Au or Sn Over Ni
 Insulator Material:PA6T Black
 Resistance To Soldering Heat:
 260°C±5°C, 10s

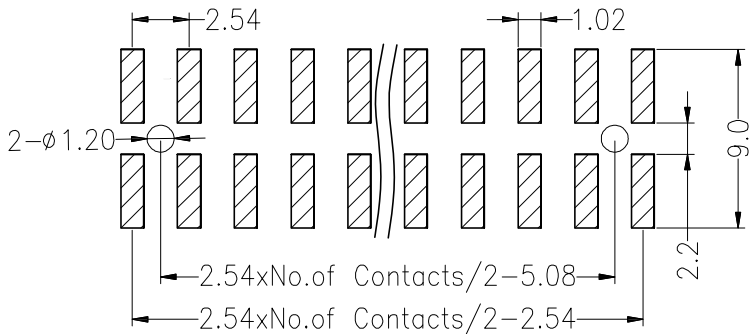

TOLERANCE: ±0.05,
 RECOMMENDED PCB LAYOUT
 (TOP VIEW)

Part number Information:

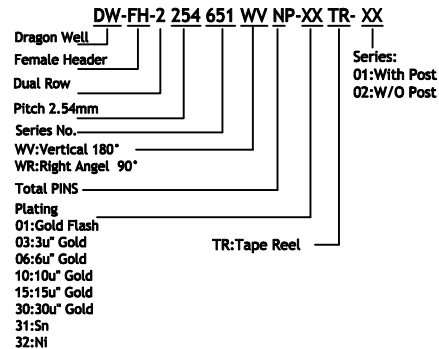

						Angle	±2°	DESIGN	Aple	2023.11.10	
						X	±0.35	CHECK	Jason	2023.11.10	
						X.X	±0.30	APPROVAL	Rix	2023.11.10	
						X.XX	±0.25				
						X.XXX	±0.10				
ECN NO.	REV	DATE	DESCRIPTION	CHANGE	APPRO.	GENERAL TOLERANCE UNLESS OTHERWISE NOTED		SCALE: N/A	UNIT:mm	A4	SHEET: 1 of 1

龍威電子有限公司
 Dragon Well Ele Dragon Well Electronics Co.,Ltd
 TITLE: 排母 2.54*5.7 双排 180° SMT U型
 MODEL NO. DW-FH-2254651WVNP-XXTR-XX
 THIS DRAWING CONTAINS INFORMATION THAT IS PROPRIETARY TO DRAGON WELL AND SHOULD NOT BE USED WITHOUT WRITTEN PERMISSION